

# BALLO L807

Parklampe / Post lights / Mastleuchte / Lyktstolper

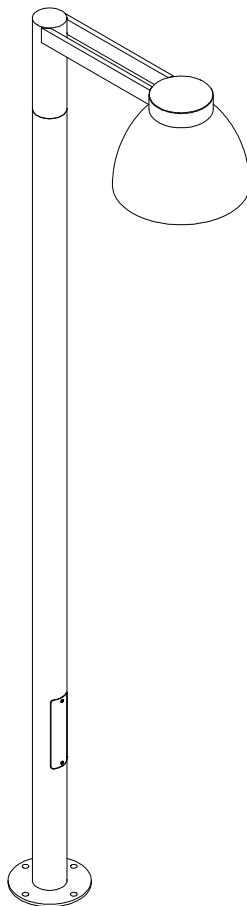

Monteringsvejledning / Mounting instructions /  
Installationsanleitung / Installationsinstruktioner

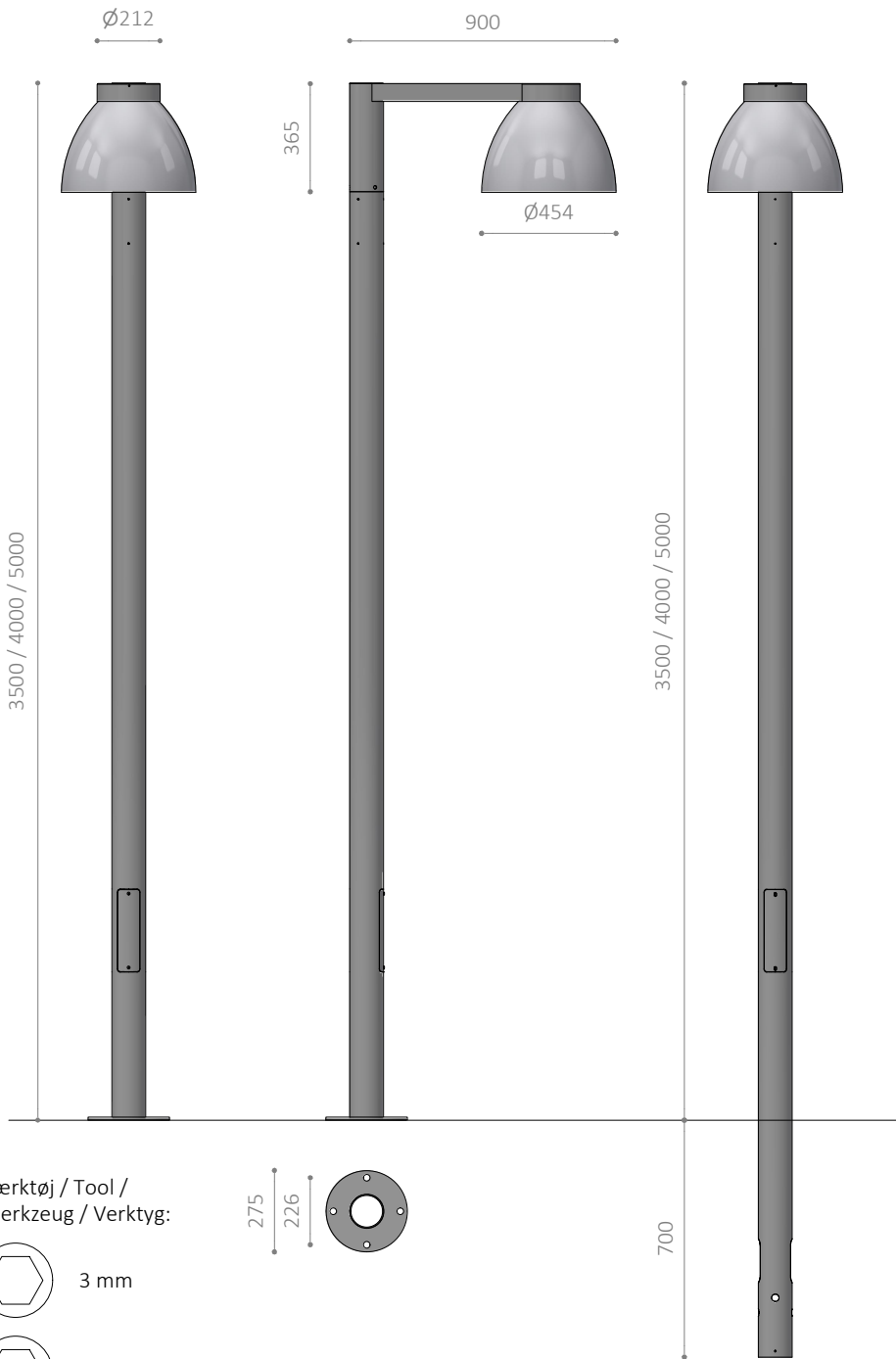

Værktøj / Tool /  
Werkzeug / Verktvg:



3 mm



4 mm

1

 4 mm

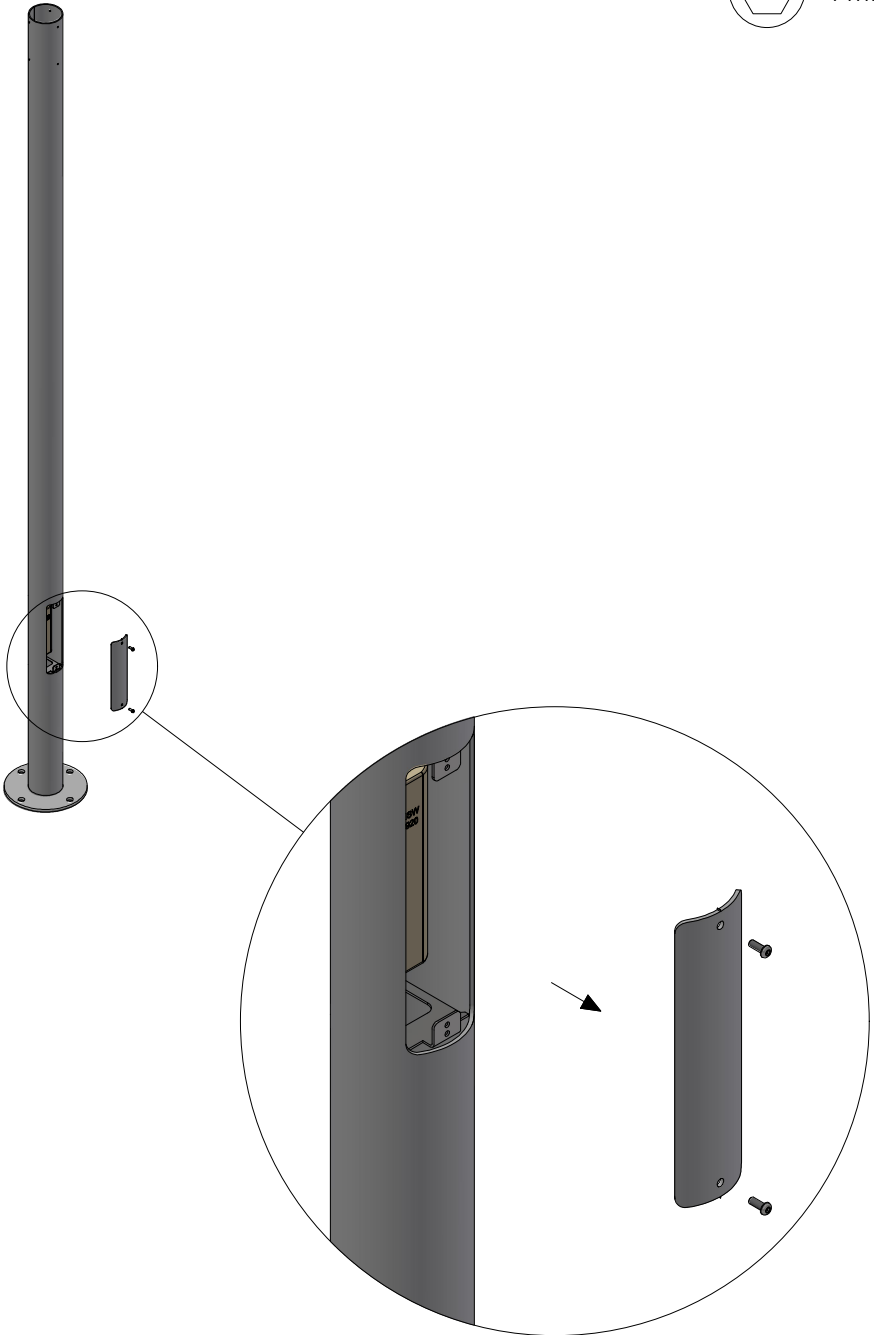

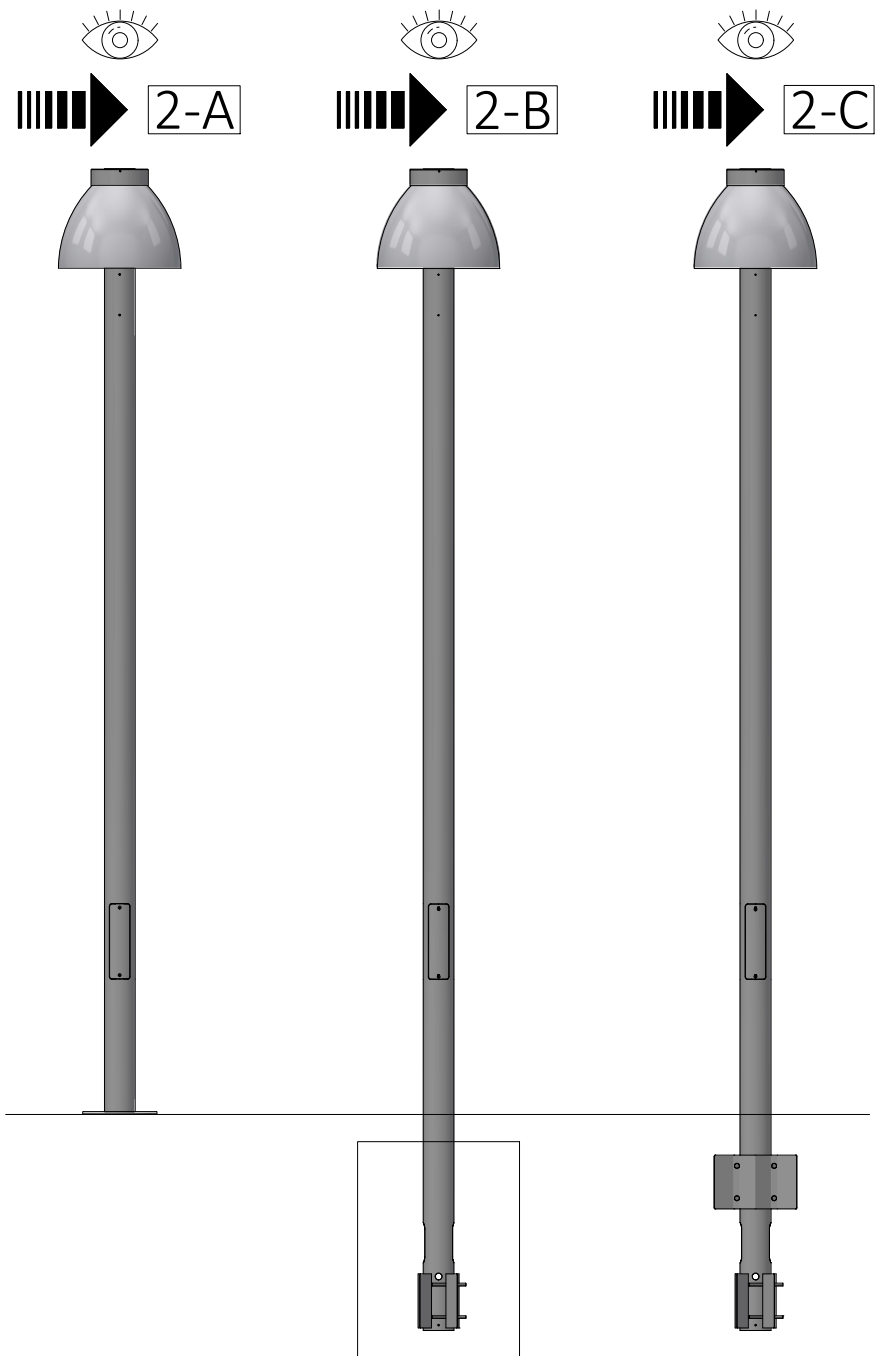

2-A

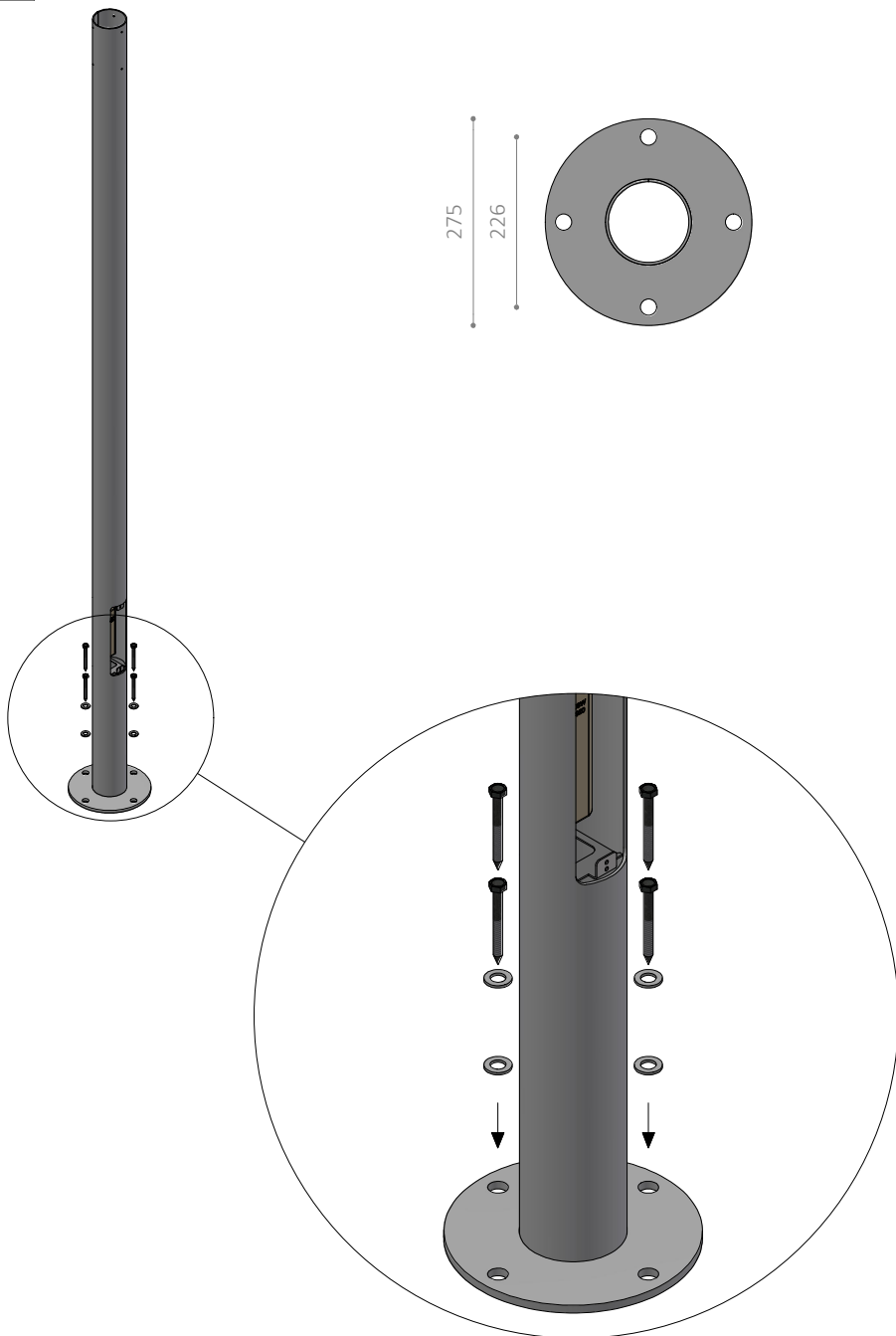

2-B

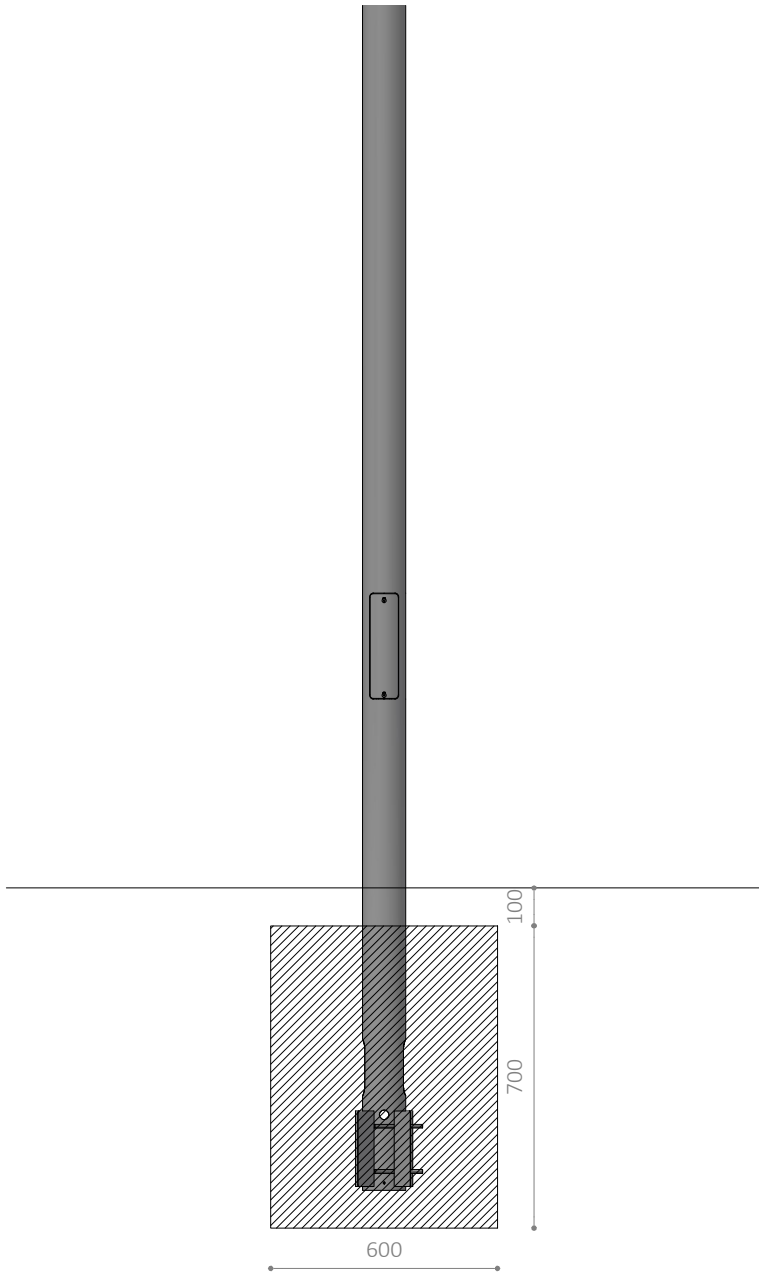

Se monteringsvejledning / See mounting instructions / Siehe  
Installationsanleitung / Se Installationsinstruktioner nr. 19651000-96

Lampas A/S, Platinvej 43, 6000 Kolding, T +45 6916 0300, info@lampas.dk, www.lampas.dk

Mont. vejl. nr. 2021650100-95 A

2-C

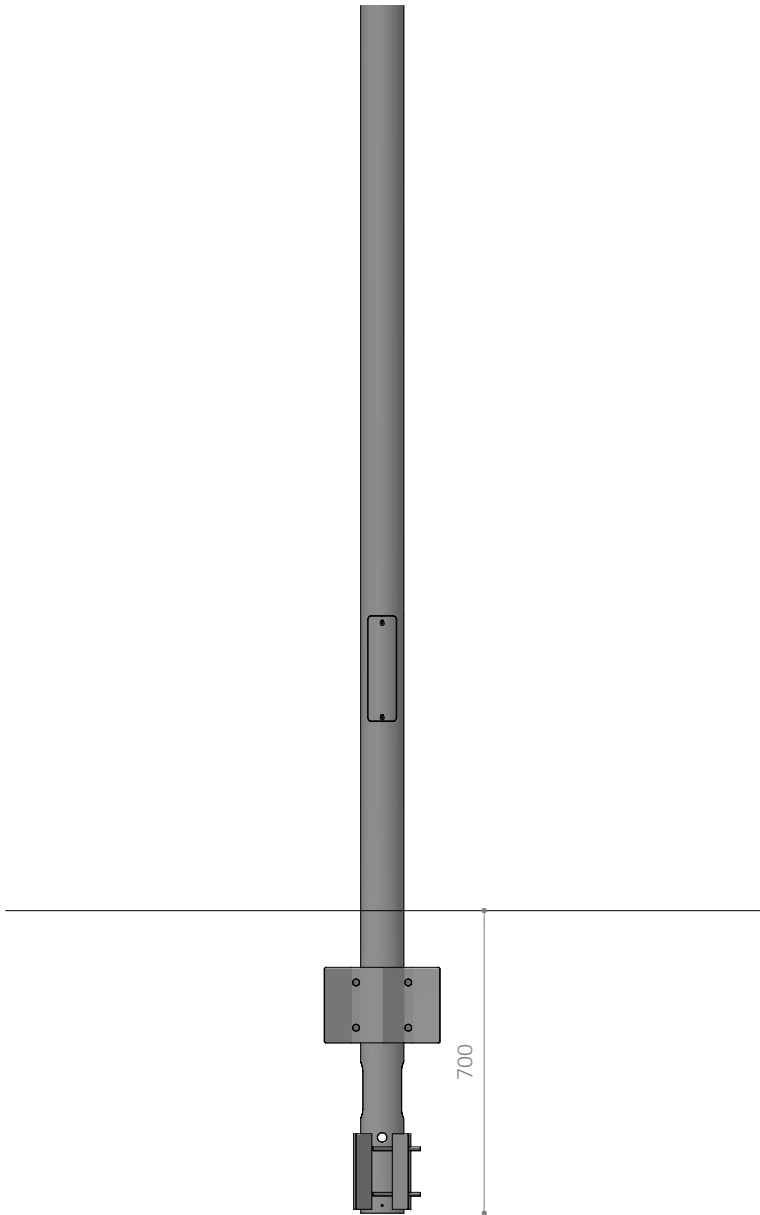

Se monteringsvejledning / See mounting instructions / Siehe  
Installationsanleitung / Se Installationsinstruktioner nr. 19651000-96

Lampas A/S, Platinvej 43, 6000 Kolding, T +45 6916 0300, info@lampas.dk, www.lampas.dk

Mont. vejl. nr. 2021650100-95 A

3





4



3 mm

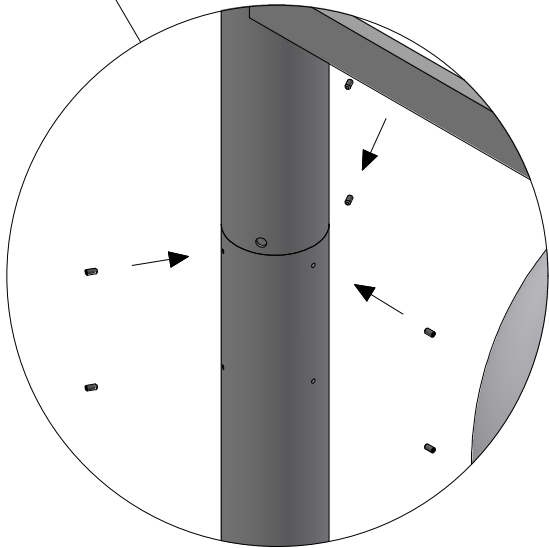
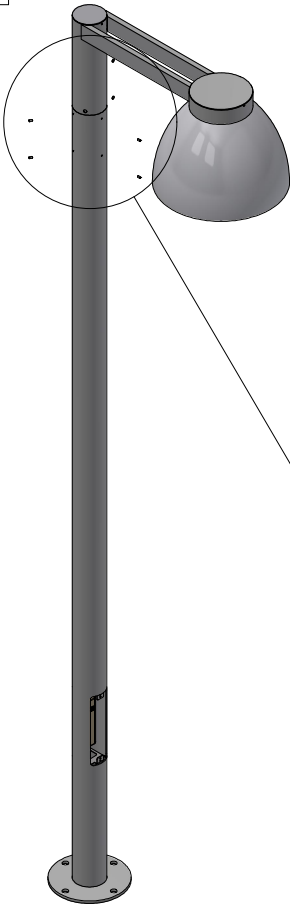

5

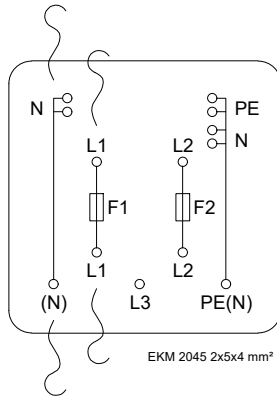
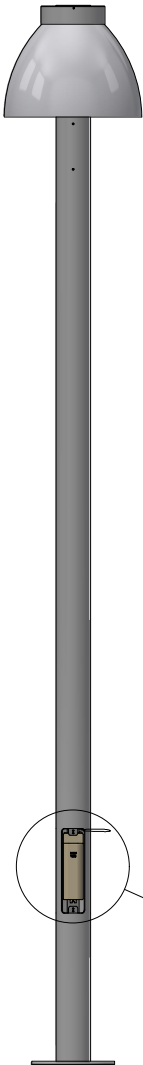

Isolationsklasse II / Insulation class II /  
Schutzklasse II / Isolationsklass II

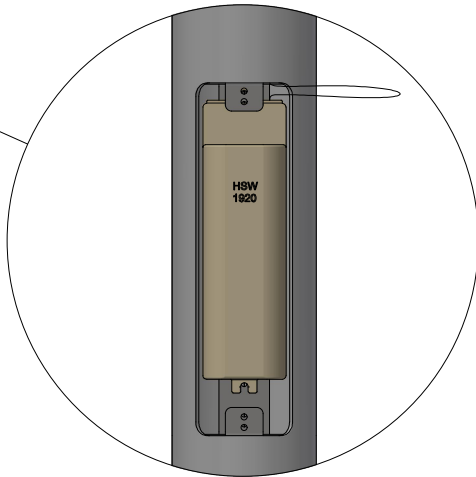

6



4 mm

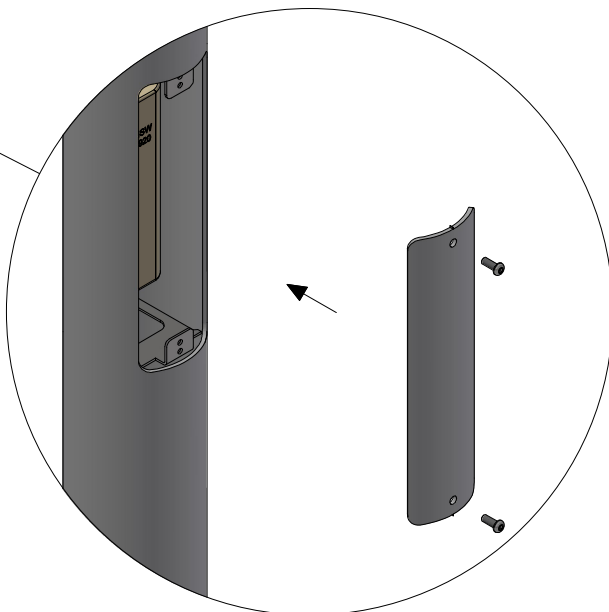
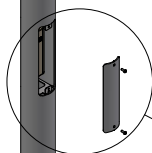
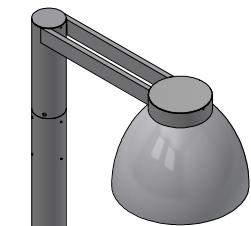



LED



220-240 V 50-60 Hz



Isolationsklasse II / Insulation class II / Schutzklasse II / Isolationsklass II



IP54

IK

IK10



53 / 57 / 68 kg



Se vedligeholdelses vejledning / See maintenance instructions /  
Siehe Wartungsanweisungen / Se underhållsinstruktioner

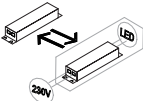

Montering samt udskiftning af lyskilde eller driver må kun udføres af  
producenten eller aut. el-installatør /  
Installation and replacement of the light source or driver may only be  
carried out by the manufacturer or by an authorised electrician /  
Die Installation und Austausch der Lichtquelle oder des Treibers darf nur  
vom Hersteller oder einem autorisierten Elektriker durchgeführt werden /  
Installation och utbyte av ljuskälla eller drivdon får endast utföras av  
tillverkaren eller en auktoriserad elektriker.

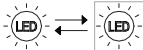

Dette produkt indeholder en lyskilde i energieffektivitetsklasse: /  
This product contains a light source of energy efficiency class: /  
Dieses Produkt enthält eine Lichtquelle der Energieeffizienzklasse: /  
Denna produkt innehåller en ljuskälla med energieffektivitetsklass:

| Luminaire                     | CCT              | Energy Efficiency Class |
|-------------------------------|------------------|-------------------------|
| Fortimo FastFlex 2x8 DA gen.5 | CCT 2200, CRI 70 | E                       |
| Fortimo FastFlex 2x8 DA gen.5 | CCT 2700, CRI 70 | E                       |
| Fortimo FastFlex 2x8 DA gen.5 | CCT 3000, CRI 70 | D                       |
| Fortimo FastFlex 2x8 DA gen.5 | CCT 4000, CRI 70 | D                       |
| Fortimo FastFlex 2x8 DA gen.5 | CCT 2700, CRI 80 | E                       |
| Fortimo FastFlex 2x8 DA gen.5 | CCT 3000, CRI 80 | E                       |
| Fortimo FastFlex 2x8 DA gen.5 | CCT 4000, CRI 80 | D                       |

# Lampas